



MAKING YOUR DREAMS A REALITY

FITTING INSTRUCTIONS

UNDER COWL BPCL-7428 and BPFL-7428

For 2nd gen Honda MSX125SF / Grom



Fitment of Under Cowl for Honda MSX125SF / GROM

BPCL-7428 and BPFL-7428

This product fits the Honda MSX125SF and requires only basic tools and a reasonable mechanical competence to install.

- 1) The first thing to do is to remove the two panels, Cover R., Side, Lower and Cover, L., Side Lower, Honda part numbers: [83680-K26-B00](#) and [83690-K26-B00](#) and replace them with the four replacement panels which are provided in the TYGA lower cowling kit.

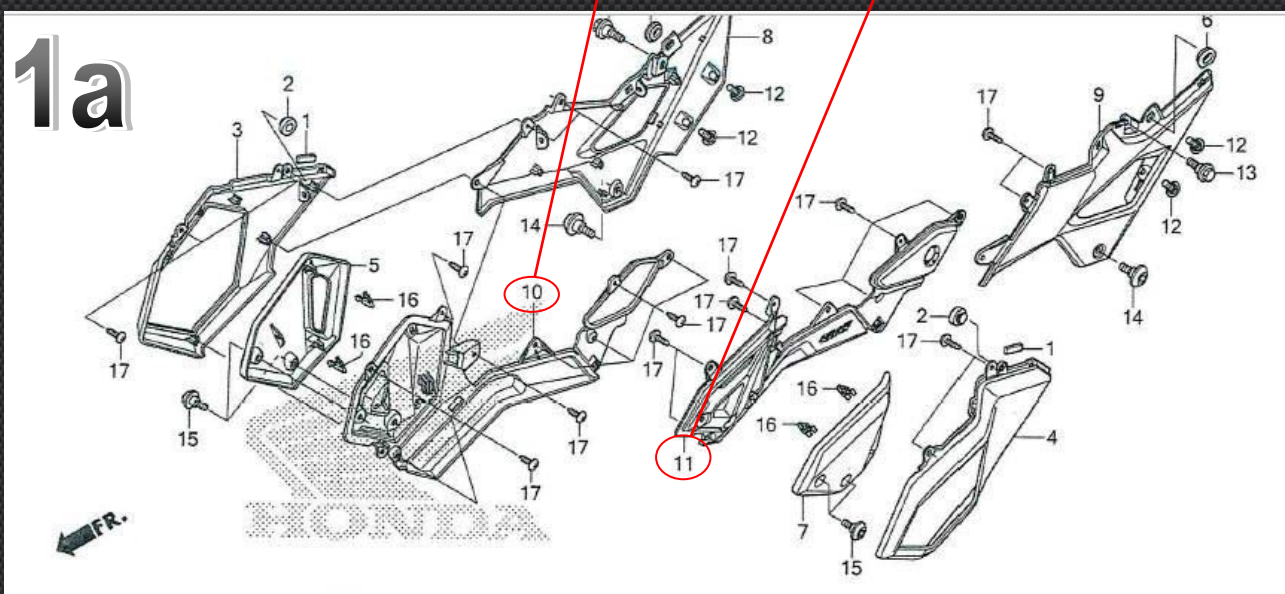

This is to enable to TYGA lower cowling to be installed in the correct position on the bike which would otherwise be compromised by the lower covers being in the way. The actual removal and replacement is quite straight forward, but like many things on this bike, it is a bit of a jigsaw puzzle and you need to be careful to remove all fasteners and bolts from not only the side covers but also the seat cowling as one of the side cover mounting bolts is covered by the side cover. Once the panels are removed, it is an easy job to switch the lower covers for the ones in the kit. Note that one of the bolts in either side is not replaced yet as this hole is used to mount the front top mounts of the lower cowling.

Once the panels are removed, it is an easy job to switch the lower covers for the ones in the kit. Note that one of the bolts in either side is not replaced yet as this hole is used to mount the front top mounts of the lower cowling.



2) Once all the panels are replaced on the bike, you can turn your attention to installing the mounting stays provided with the kit. There are four in total, see placement of the stays as shown in the photos. Note the left stay BPSY-0197L is different to the right one, BPSY-0197R. The orientation of these stays can be adjusted later if necessary, but for now get them installed and ready to accept the lower cowling.

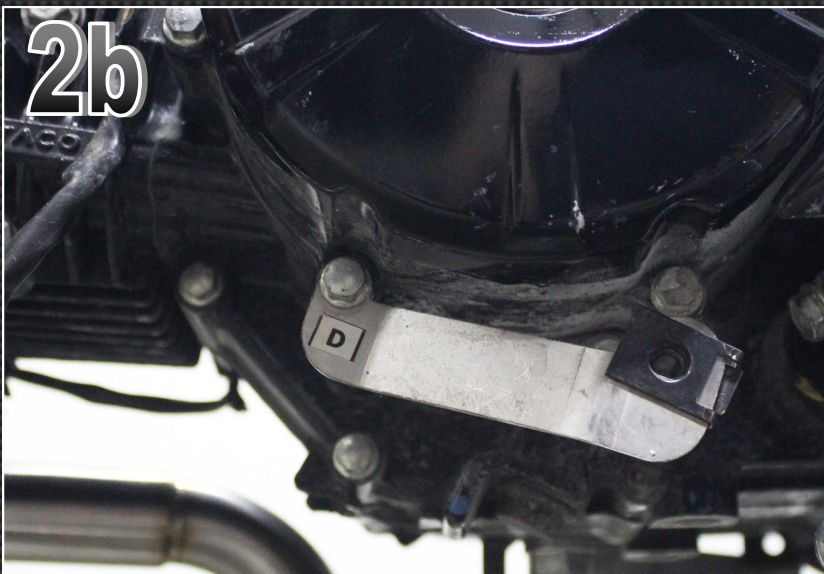
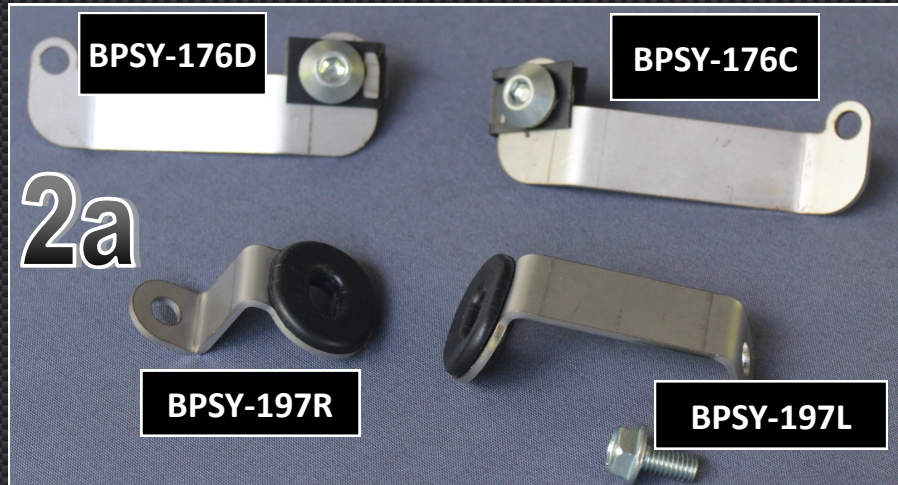

**LEFT side lower stay:
BPSY176D**

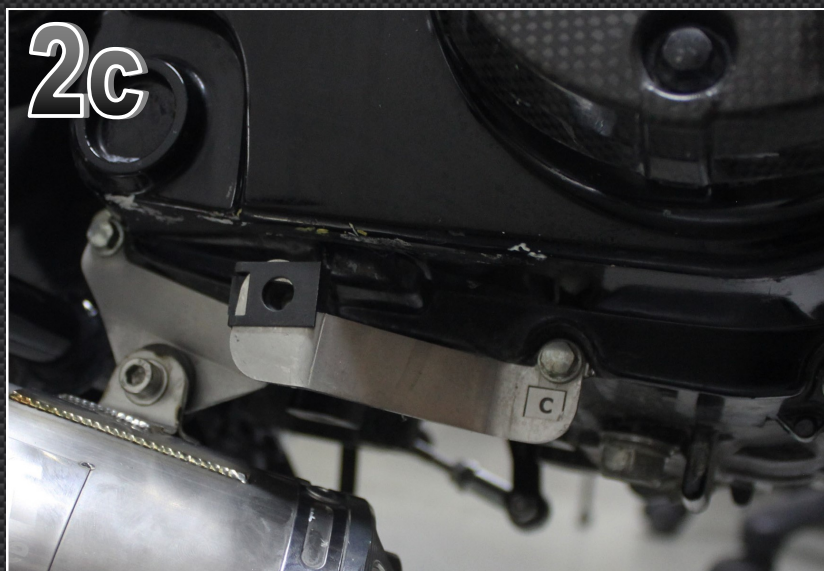

**RIGHT side lower stay:
BPSY176C**



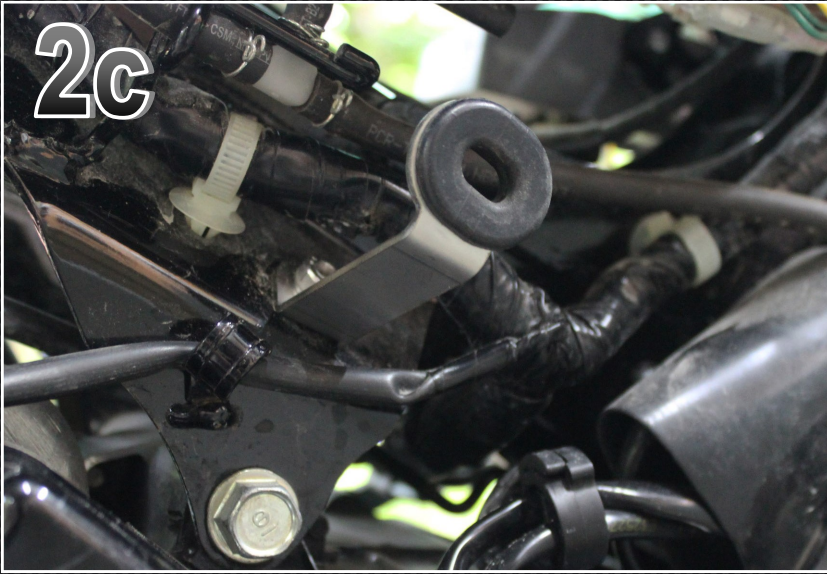

LEFT side upper stay:
BPSY197L

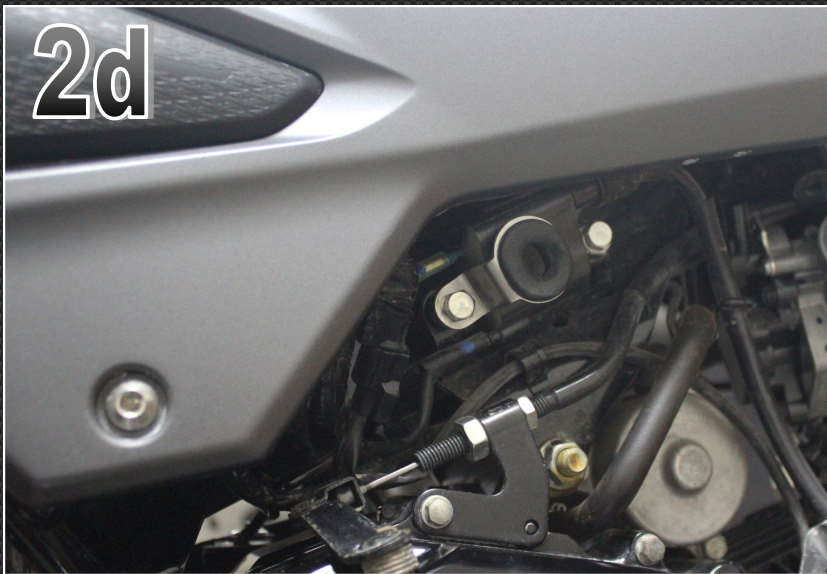

RIGHT side Upper stay:
BPSY197R



3) Before installing the lower cowling, place the bike on a paddock stand to gain some height with the floor if possible or at least put something on the floor to prevent the lower cowling from being scratched when you install it. It is also helpful to have a buddy to help you as it is difficult to guide the lower cowling in place by yourself. You need to come in from one side and slightly from the front making sure the lower cowling doesn't scratch or get scratched on anything so take your time and be patient. Be particularly careful not to hook the lower cowling on the inside of the stays BPSY-0176C and BPSY-0176D.



Once in the approximate position, it is easy to push the spigots on the rear top part of the lower cowling into position on the rubber grommets on stays BPSY-0197 L and R and this will minimize risk of damage while giving you more free hands to install the other mounting positions.

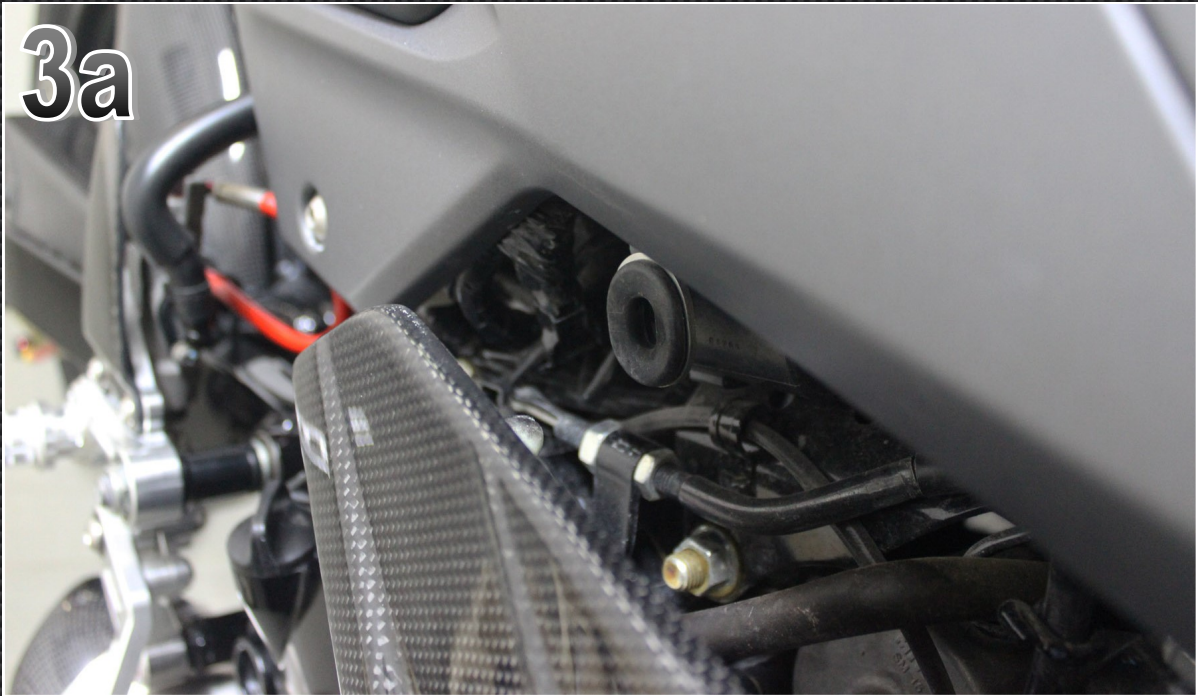

The next positions to get in place are the front top ones. There are two metal stays which line up with the holes which you have left vacant from step 1 When you installed the Tyga replacement Covers, Side, Lower. Use the self-tapping bolt that originally was in the hole to install the lower stays in this position. Make sure the top edge of the lower cowling sits flush and neatly below the side covers.



The last positions to mount are the lower ones and the holes should line up with the stays and the clips on the stays. It is possible to move the clips to find an optimum position. Makes sure everything is tight and you are now ready to ride!

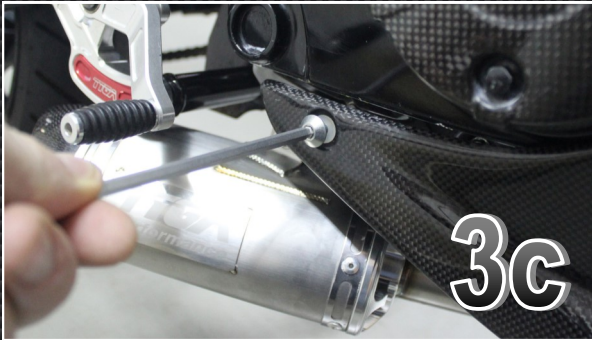

**CHECK OUT OUR OTHER AWESOME PRODUCTS FOR THE
HONDA MSX125SF / GROM**

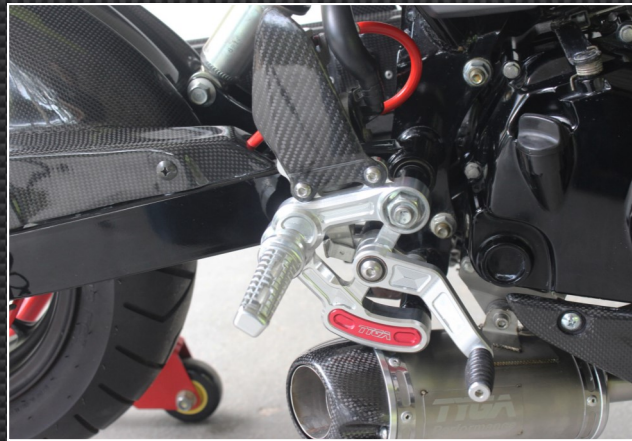

www.tyga-performance.com